

RM SERIES

RM2010LH0

2 CHANGE-OVER CONTACTS, 8 PINS, DPDT.

TYPE

RM2010LH0
Industrial Relay Multi-Voltage
2 CO

MAX. CONTACT LOAD

6 A / 250 V AC1 0,5 A / 110 V DC1
6 A / 30 V DC1 0,2 A / 220 V DC1

CONTACT

Material	Standard	AgNi
	Optional	AgNi + 0,2 μ Au
	Optional	AgNi + 10 μ Au
Rated current / Max. peak current		6 A / 30 A
Rated voltage / Max. switching voltage AC-1		250 V / 400 V
Rated load AC15 (250 V)		750 VA
Min. switching load		10 V / 10 mA
		5 V / 5 mA (10 μ Au)

COIL

Operation range	24 ... 240 V (AC/DC)
Rated power (AC/DC)	$\leq 1,3$ W
Release voltage	$\geq 0,1 \times U_N$
Coil resistance	$\pm 10\%$

INSULATION (Vrms, 1 min)

Contact open	1 KV
Coil /Contacts	2,5 KV
Insulation IEC 61810-1	2,5 KV / 3
Between contacts	2,5 KV

SPECIFICATIONS

Ambient temperature	- 40 °C ... + 80 °C
Operation / Release time	20 ms / 20 ms
Protection category	IP40
Electrical life DC / Mechanical life	1·10 ⁵ op / 10·10 ⁶ op (AC) 20·10 ⁶ op (DC)
Weight	90 g

ACCESSORIES

Sockets SMB20D, SMT20D, SMW20F, SMP20F

ORDERING CODE

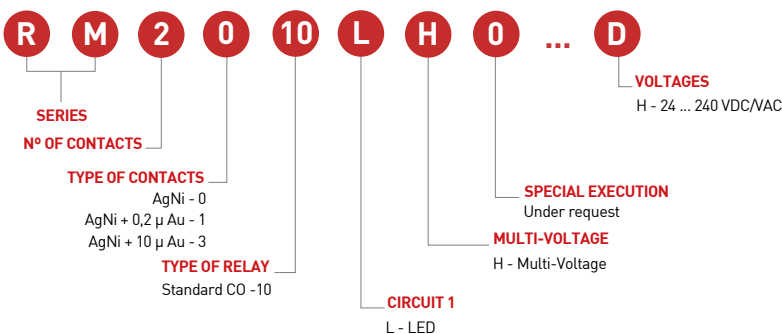

CONNECTION DIAGRAM

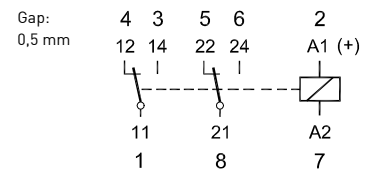

FIG. 1 ELECTRICAL LIFE AC LOAD

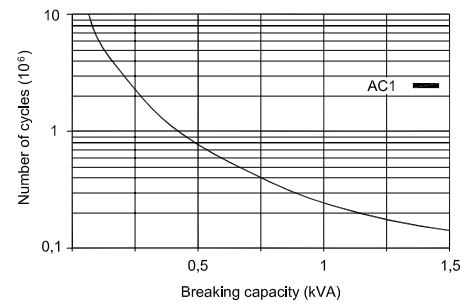
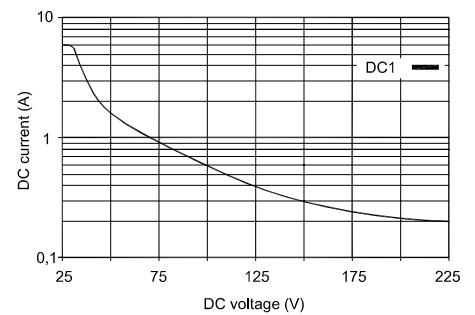
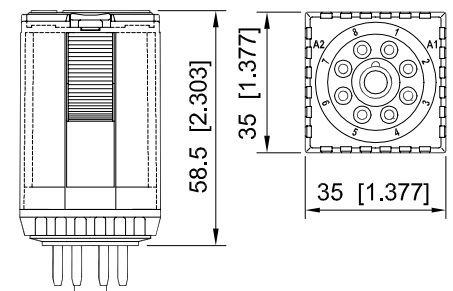

FIG. 2 MAX. DC BREAKING CAPACITY



DIMENSIONS mm [inch]



TECHNICAL APPROVALS



IEC 61810; EN 60947

RM SERIES

RM3010LH0

3 CHANGE-OVER CONTACTS, 11 PINS, TPDT.

TYPE

RM3010LH0
Industrial Relay Multi-Voltage
3 CO

MAX. CONTACT LOAD

6 A / 250 V AC1 0,5 A / 110 V DC1
6 A / 30 V DC1 0,2 A / 220 V DC1

CONTACT

Material	Standard	AgNi
	Optional	AgNi + 0,2 μ Au
	Optional	AgNi + 10 μ Au
Rated current / Max. peak current		6 A / 30 A
Rated voltage / Max. switching voltage AC-1		250 V / 400 V
Rated load AC15 (250 V)		750 VA
Min. switching load		10 V / 10 mA
		10 V / 10 mA (10 μ A)

COIL

Operation range	24 ... 240 V (AC/DC)
Rated power (AC/DC)	$\leq 1,3$ W
Release voltage	$\geq 0,1 \times U_N$
Coil resistance	$\pm 10\%$

INSULATION (Vrms, 1 min)

Contact open	1 kV
Coil / Contacts	2,5 kV
Insulation IEC 61810-1	2,5 kV / 3
Between contacts	2,5 kV

SPECIFICATIONS

Ambient temperature	- 40 °C ... + 80 °C
Operation / Release time	20 ms / 20 ms
Protection category	IP40
Electrical life DC / Mechanical life	1·10 ⁵ op / 10·10 ⁶ op (AC) 20·10 ⁶ op (DC)
Weight	90 g

ACCESSORIES

Sockets SMB30D, SMT30D, SMB30P, SMB30S, SMW30F, SMP30F

ORDERING CODE

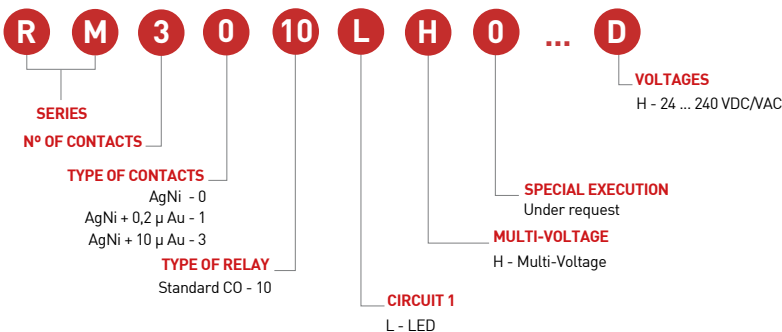

CONNECTION DIAGRAM

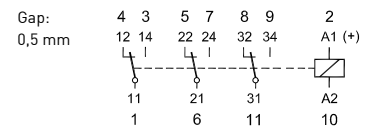

FIG. 1 ELECTRICAL LIFE AC LOAD

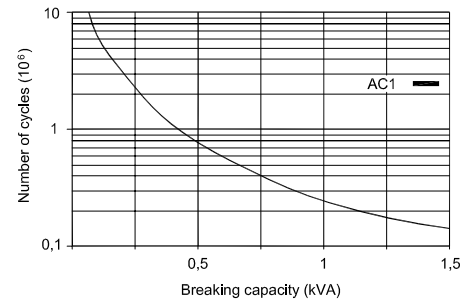
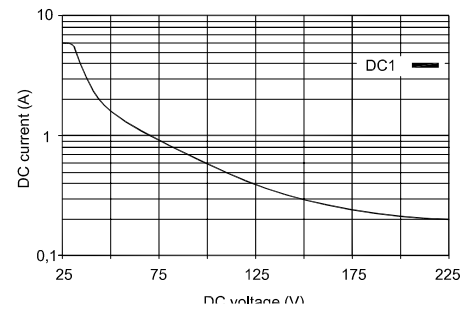
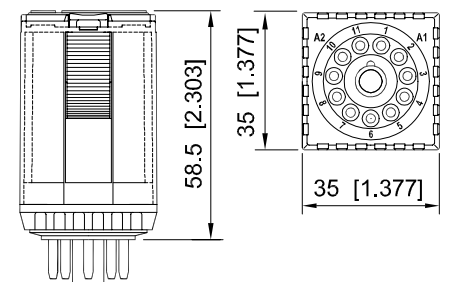

FIG. 2 MAX. DC BREAKING CAPACITY



DIMENSIONS mm [inch]



TECHNICAL APPROVALS



In process In process In process In process
IEC 61810; EN 60947

RM SERIES

RM4010LH0

4 CHANGE-OVER CONTACTS, 14 FASTON, FPDT.

TYPE

RM40100LH0
Industrial Relay Multi-Voltage
4 CO

MAX. CONTACT LOAD

5 A / 250 V AC1 0,5 A / 110 V DC1
5 A / 30 V DC1 0,2 A / 220 V DC1

CONTACT

Material	Standard	AgNi
	Optional	AgNi + 0,2 μ Au
	Optional	AgNi + 10 μ Au
Rated current / Max. peak current		5 A / 30 A
Rated voltage / Max. switching voltage AC-1		250 V / 400 V
Rated load AC15 (250 V)		750 VA
Min. switching load		10 V / 10 mA
		5 mA / 10 V (10 μ Au)

COIL

Operation range	24 ... 240 V (AC/DC)
Rated power (AC/DC)	$\leq 1,4$ W
Release voltage	$\geq 0,1 \times U_N$
Coil resistance	$\pm 10\%$

INSULATION (Vrms, 1 min)

Contact open	1 KV
Coil /Contacts	2,5 KV
Insulation IEC 61810-1	2,5 KV / 3
Between contacts	2,5 KV

SPECIFICATIONS

Ambient temperature	- 40 °C ... + 80 °C
Operation / Release time	20 ms / 20 ms
Protection category	IP40
Electrical life DC / Mechanical life	1·10 ⁵ op / 10·10 ⁶ op (AC) 20·10 ⁶ op (DC)
Weight	90 g

ACCESSORIES

Sockets SMT40D, SMW40F, SMP40X, SMP40F

ORDERING CODE

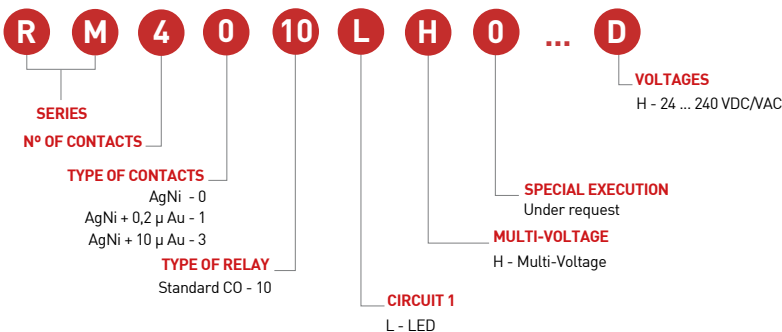

CONNECTION DIAGRAM

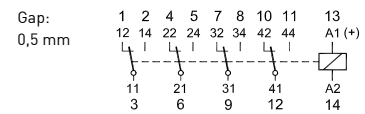

FIG. 1 ELECTRICAL LIFE AC LOAD

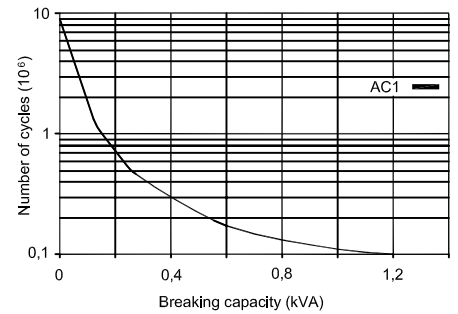
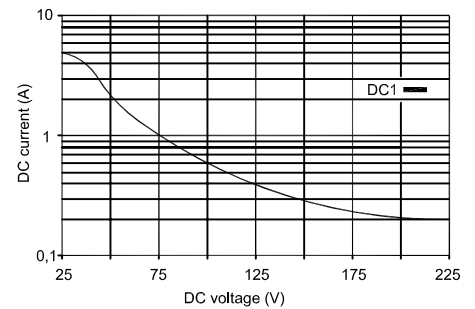
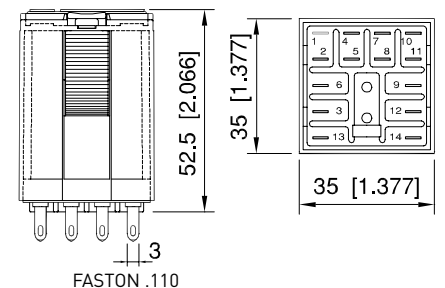

FIG. 2 MAX. DC BREAKING CAPACITY



DIMENSIONS mm [inch]



TECHNICAL APPROVALS



In process In process In process In process

IEC 61810; EN 60947

RP SERIES

RP2010LH0

2 CHANGE-OVER CONTACTS, 8 FASTON, DPDT.

TYPE

RP2010LH0
Power Relay Multi-Voltage
2 CO

MAX. CONTACT LOAD

8 A / 400 V AC1 0,5 A / 110 V DC1
8 A / 30 V DC1 0,2 A / 220 V DC1

CONTACT

Material	Standard	AgNi
	Optional	AgNi + 0,2 µ Au
	Optional	AgNi + 10 µ Au
Rated current / Max. peak current	8 A / 40 A	
Rated voltage / Max. switching voltage AC-1	400 V / 400 V	
Rated load AC15 (250 V)	1 kVA	
Min. switching load	10 V / 10 mA	
	5 V / 5 mA (10 µ Au)	

COIL

Operation range	24 ... 240 V (AC/DC)
Rated power (AC/DC)	≤ 1,4 W
Release voltage	≥ 0,1 x U _N
Coil resistance	±10%

INSULATION (V_{rms}, 1 min)

Contact open	1 kV
Coil /Contacts	4 kV
Insulation IEC 61810-1	4 kV / 3
Between contacts	4 kV

SPECIFICATIONS

Ambient temperature	- 40 °C ... + 80 °C
Operation / Release time	20 ms / 20 ms
Protection category	IP40
Electrical life DC / Mechanical life	1·10 ⁵ op / 10·10 ⁶ op (AC) 20·10 ⁶ op (DC)
Weight	90 g

ACCESSORIES

Sockets SPT30D, SPW30F, SPP30X, SPP30F

ORDERING CODE

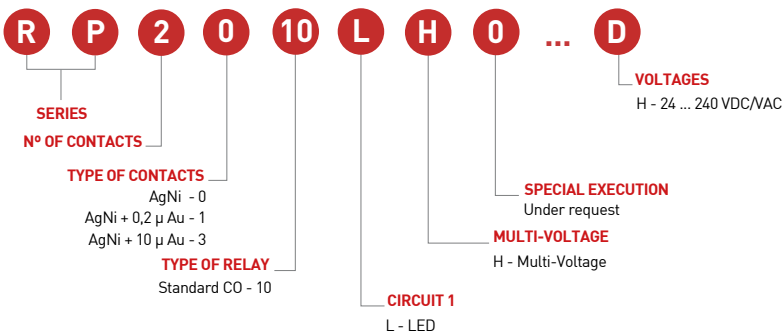

CONNECTION DIAGRAM

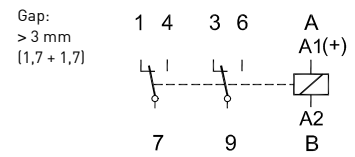

FIG. 1 ELECTRICAL LIFE AC LOAD

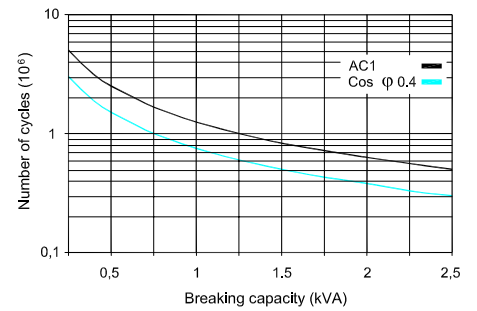
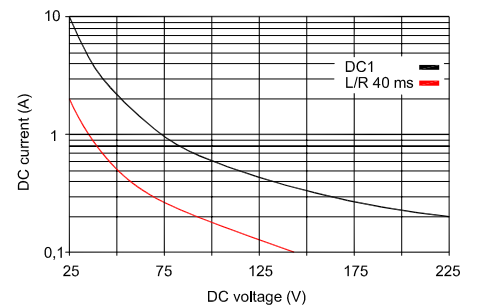
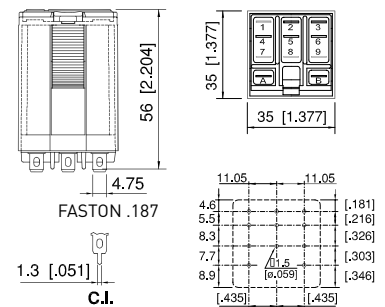

FIG. 2 MAX. DC BREAKING CAPACITY



DIMENSIONS mm [inch]



TECHNICAL APPROVALS



IEC 61810; EN 60947

RP SERIES

RP3010LH0

3 CHANGE-OVER CONTACTS, 11 FASTON, TPDT.

TYPE

RP3010LH0
Power Relay Multi-Voltage
3 CO

MAX. CONTACT LOAD

8 A / 400 V AC1 0,5 A / 110 V DC1
8 A / 30 V DC1 0,2 A / 220 V DC1

CONTACT

Material	Standard	AgNi
	Optional	AgNi + 0,2 μ Au
	Optional	AgNi + 10 μ Au
Rated current / Max. peak current		8 A / 40 A
Rated voltage / Max. switching voltage AC-1		400 V / 400 V
Rated load AC15 (250 V)		1 kVA
Min. switching load		10 V / 10 mA
		5 V / 5 mA (10 μ Au)

COIL

Operation range	24 ... 240 V (AC/DC)
Rated power (AC/DC)	$\leq 1,4$ W
Release voltage	$\geq 0,1 \times U_N$
Coil resistance	$\pm 10\%$

INSULATION (Vrms, 1 min)

Contact open	1 KV
Coil /Contacts	4 KV
Insulation IEC 61810-1	4 KV / 3
Between contacts	4 KV

SPECIFICATIONS

Ambient temperature	- 40 °C ... + 80 °C
Operation / Release time	20 ms / 20 ms
Protection category	IP40
Electrical life DC / Mechanical life	1·10 ⁵ op / 10·10 ⁶ op (AC) 20·10 ⁶ op (DC)
Weight	90 g

ACCESSORIES

Sockets SPT30D, SPW30F, SPP30X, SPP30F

ORDERING CODE

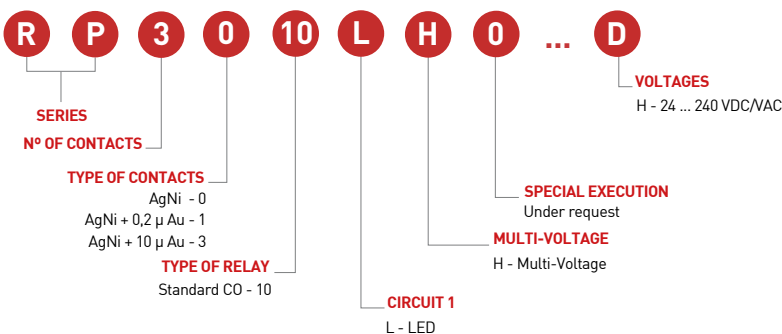

CONNECTION DIAGRAM

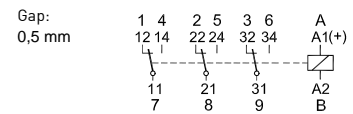

FIG. 1 ELECTRICAL LIFE AC LOAD

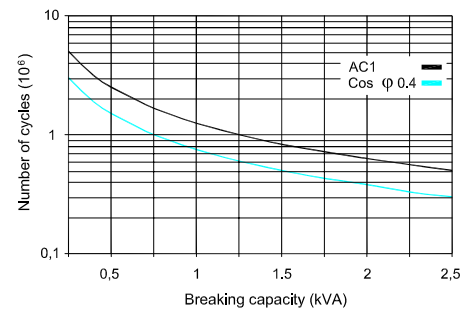
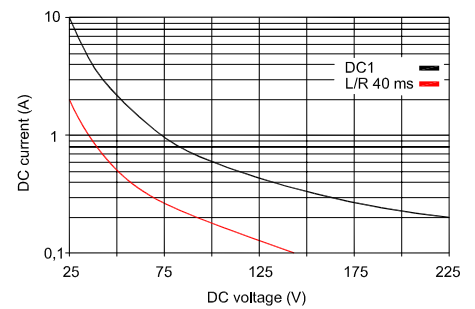
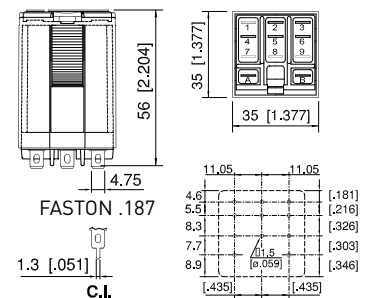

FIG. 2 MAX. DC BREAKING CAPACITY



DIMENSIONS mm [inch]



TECHNICAL APPROVALS



IEC 61810; EN 60947

RQ SERIES

RQ2010LH0

2 CHANGE-OVER CONTACTS, 8 FASTON, DPDT.

TYPE

RQ2010LH
Miniature Relay Multi-Voltage
1 CO

MAX. CONTACT LOAD

5 A / 250 V AC1 0,5 A / 110 V DC1
5 A / 30 V DC1 0,2 A / 220 V DC1

CONTACT

Material	Standard	AgNi
	Optional	AgNi + 0,2 μ Au
	Optional	AgNi + 10 μ Au
Rated current / Max. peak current		5 A / 30 A
Rated voltage / Max. switching voltage AC-1		250 V / 400 A
Rated load AC15 (250 V)		750 VA
Min. switching load		10 mA / 10 V
		5 mA / 5 V (10 μ Au)

COIL

Operation range	24 ... 240 V (AC/DC)
Rated power (AC/DC)	≤ 1 W
Release voltage	$\geq 0,1 \times U_N$
Coil resistance	$\pm 10\%$

INSULATION (Vrms, 1 min)

Contact open	1 KV
Coil /Contacts	2,5 KV
Insulation IEC 61810-1	2,5 KV/3
Between contacts	2,5 KV

SPECIFICATIONS

Ambient temperature	- 40 °C ... + 80 °C
Operation / Release time	20 ms / 20 ms
Protection category	IP40
Electrical life DC / Mechanical life	1·10 ⁵ op / 10·10 ⁶ op (AC) 20·10 ⁶ op (DC)
Weight	43 g

ACCESSORIES

Sockets	SQB20D, SQW20X, SQP20X, SQP20F, SQB20I
---------	--

ORDERING CODE

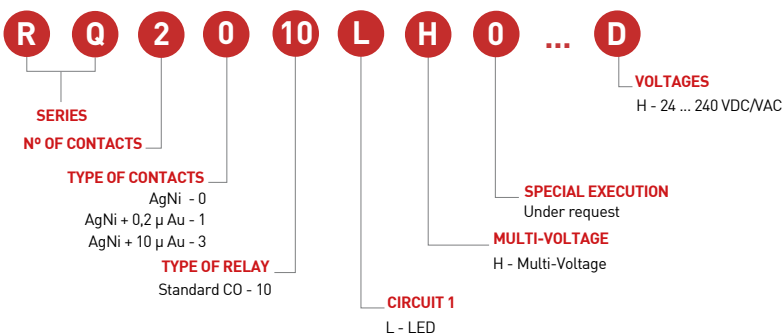

CONNECTION DIAGRAM

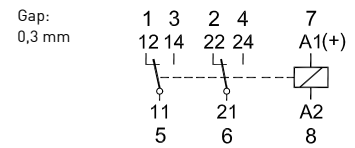

FIG. 1 ELECTRICAL LIFE AC LOAD

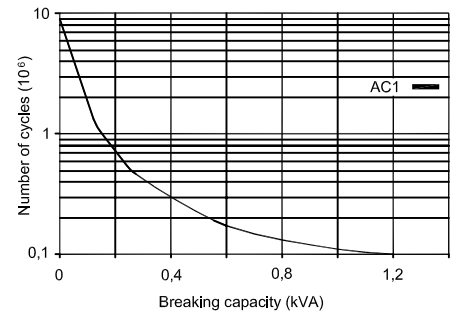
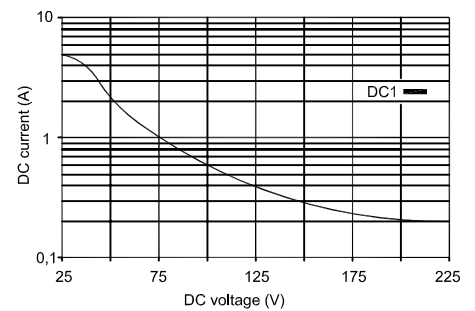
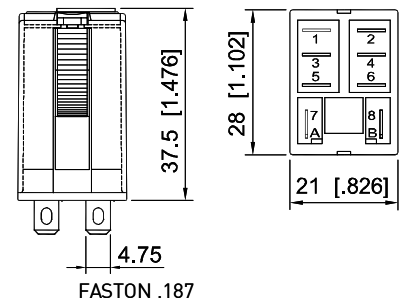

FIG. 2 MAX. DC BREAKING CAPACITY



DIMENSIONS mm [inch]



TECHNICAL APPROVALS



In process In process In process In process
IEC 61810; EN 60947

RQ SERIES

RQ4110LH0

4 CHANGE-OVER CONTACTS, 14 FASTON, FPDT.

TYPE

RQ4110LH0
Miniature Relays Multi-Voltage
4 CO

MAX. CONTACT LOAD

3 A / 250 V AC1 3 A / 30 V DC1

CONTACT

Material	Standard	AgNi + 0,2 μ Au
	Optional	AgNi + 10 μ Au

Rated current / Max. peak current	3 A / 15 A
Rated voltage / Max. switching voltage AC-1	250 V / 250 A
Rated load AC15 (250 V)	350 VA
Min. switching load	10 mA / 10 V
	5 mA / 5 V (10 μ Au)

COIL

Operation range	24 ... 240 V (AC/DC)
Rated power (AC/DC)	≤ 1 W
Release voltage	$\geq 0,1 \times U_N$
Coil resistance	$\pm 10\%$

INSULATION (Vrms, 1 min)

Contact open	1 KV
Coil /Contacts	2,5 KV
Insulation IEC 61810-1	2,5 KV/3
Between contacts	2 KV

SPECIFICATIONS

Ambient temperature	- 40 $^{\circ}$ C ... + 80 $^{\circ}$ C
Operation / Release time	10 ms / 6 ms
Protection category	IP40
Electrical life DC / Mechanical life	1 \cdot 10 ⁵ op / 10 \cdot 10 ⁶ op (AC) 20 \cdot 10 ⁶ op (DC)
Weight	43 g

ACCESSORIES

Sockets SQB40D, SQW40F, SQP40X, SQP40F

ORDERING CODE

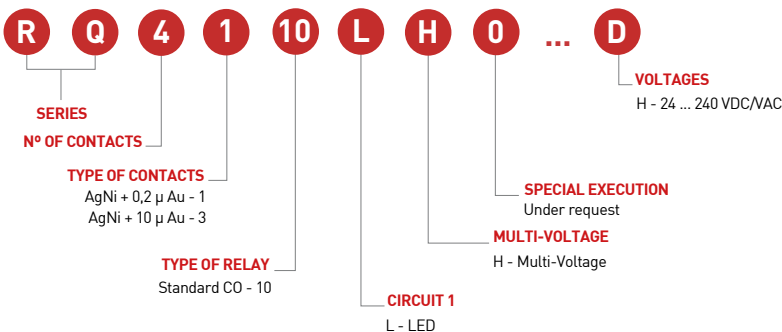

CONNECTION DIAGRAM

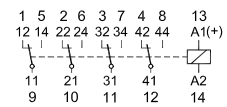

FIG. 1 ELECTRICAL LIFE AC LOAD

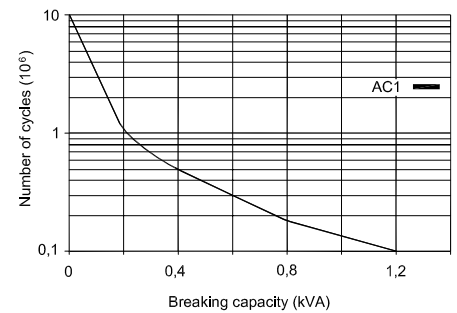
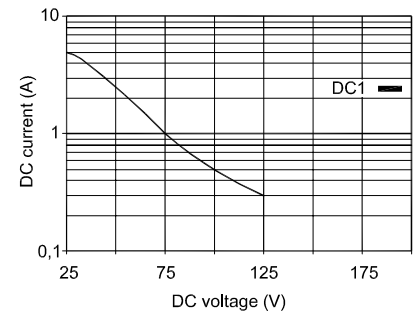
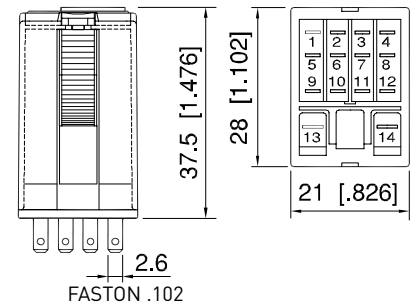

FIG. 2 MAX. DC BREAKING CAPACITY



DIMENSIONS mm [inch]



TECHNICAL APPROVALS



In process In process In process In process
IEC 61810; EN 60947

RF SERIES

RF1010LH0

1 CHANGE-OVER CONTACT, 5 FASTON, SPDT.

TYPE

RF1010LH0
Interface Relay Multi-Voltage
1 CO

MAX. CONTACT LOAD

10 A / 250 V AC1 0,5 A / 110 V DC1
10 A / 30 V DC1 0,2 A / 220 V DC1
13 A / 250 V AC1 (UL)

CONTACT

Material	Standard	AgNi
	Optional	AgNi + 10 μ Au
	Optional	Ag Sn O2
Rated current / Max. peak current		10 A / 30 A
Rated voltage / Max. switching voltage AC-1		250 V / 400 V
Rated load AC15 (250 V)		750 VA
Min. switching load		10 V / 10 mA
		5 V / 5 mA (10 μ Au)

COIL

Operation range	24 ... 240 V (AC/DC)
Rated power (AC/DC)	≤ 0,7 W
Release voltage	≥ 0,1 x U _N
Coil resistance	±10%

INSULATION (V_{rms}, 1 min)

Contact open	1 kV
Coil /Contacts	5 kV
Insulation IEC 61810-1	4 kV/3
Between contacts	

SPECIFICATIONS

Ambient temperature	- 40 °C ... + 80 °C
Operation / Release time	20 ms / 10 ms
Protection category	IP40
Electrical life DC / Mechanical life	1·10 ⁵ op / 10·10 ⁶ op (AC) 20·10 ⁶ op (DC)
Weight	21 g

ACCESSORIES

Sockets	FG5696
---------	--------

ORDERING CODE

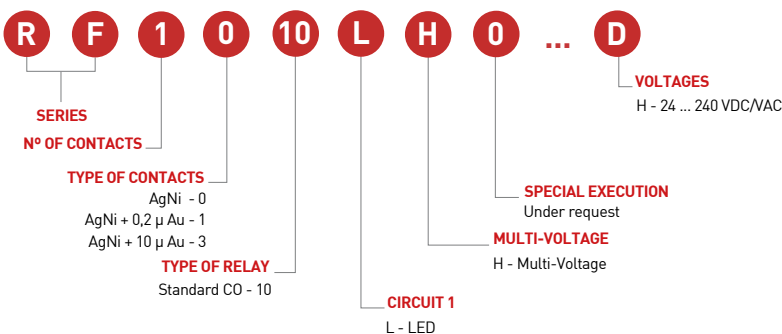

CONNECTION DIAGRAM

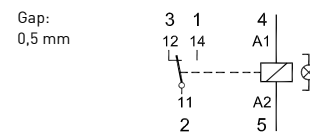

FIG. 1 ELECTRICAL LIFE AC LOAD

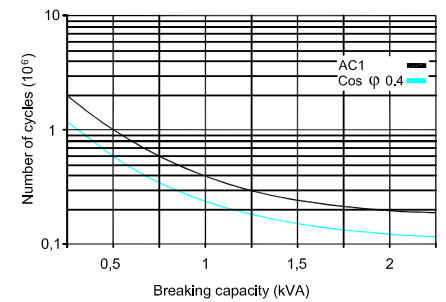
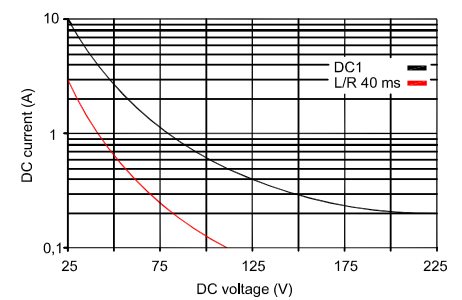
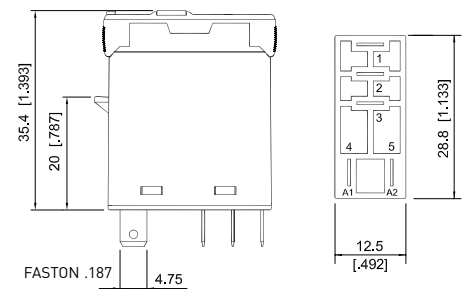

FIG. 2 MAX. DC BREAKING CAPACITY



DIMENSIONS mm [inch]



TECHNICAL APPROVALS



In process In process In process In process

IEC 61810; EN 60947

RF SERIES

RF2110LH0

2 CHANGE-OVER CONTACTS, 8 FASTON, DPDT.

TYPE

RF2110LH0
Interface Relay Multi-Voltage
2 CO

MAX. CONTACT LOAD

5 A / 250 V	AC1	0,5 A / 110 V DC1
5 A / 30 V	DC1	0,2 A / 220 V DC1

CONTACT

Material	Standard	AgNi + 0,2 μ Au
	Optional	AgNi + 10 μ Au

Rated current / Max. peak current	5 A / 15 A
Rated voltage / Max. switching voltage AC-1	250 V / 400 V
Rated load AC15 (250 V)	350 VA
Min. switching load	10 V / 10 mA
	5 V / 5 mA (10 μ Au)

COIL

Operation range	24 ... 240 V (AC/DC)
Rated power (AC/DC)	$\leq 0,7$ W
Release voltage	$\geq 0,1 \times U_N$
Coil resistance	$\pm 10\%$

INSULATION (Vrms, 1 min)

Contact open	1 kV
Coil /Contacts	5 kV
Insulation IEC 61810-1	4 kV/3
Between contacts	3 kV

SPECIFICATIONS

Ambient temperature	- 40 °C ... + 80 °C
Operation / Release time	20 ms / 10 ms
Protection category	IP40
Electrical life DC / Mechanical life	1·10 ⁵ op / 10·10 ⁶ op (AC) 20·10 ⁶ op (DC)
Weight	21 g

ACCESSORIES

Sockets	FG5697
---------	--------

ORDERING CODE

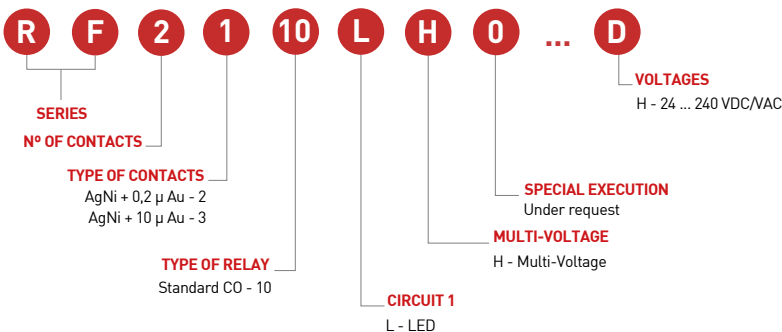

CONNECTION DIAGRAM

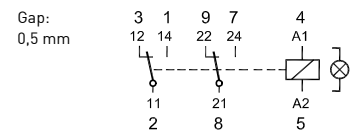

FIG. 1 ELECTRICAL LIFE AC LOAD

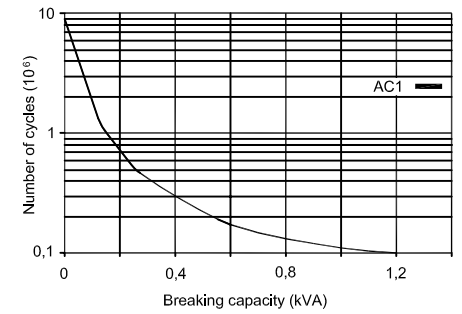
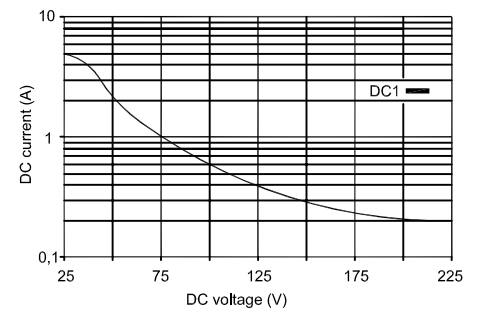
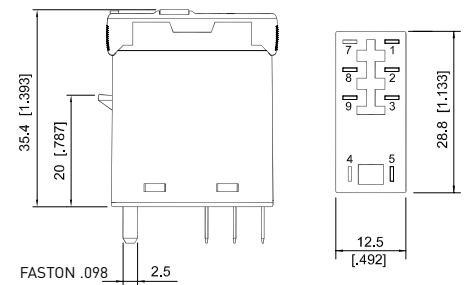

FIG. 2 MAX. DC BREAKING CAPACITY



DIMENSIONS mm [inch]



TECHNICAL APPROVALS



In process In process In process In process

IEC 61810; EN 60947

RT SERIES

RT1010NH0 (STB10LH)

SLIM INTERFACE RELAY



TYPE

RT1010NH0 / STB10LH
Slim Relay Multi-voltage for PCB or DIN rail
1 CO

MAX. CONTACT LOAD

6 A / 250 V	AC1	0,5 A / 110 V DC1
6 A / 30 V	DC1	0,2 A / 220 V DC1

CONTACT

Material Standard AgNi

Rated current / Max. peak current	6 A / 15 A
Rated voltage / Max. switching voltage AC-1	250 V / 400 V
Rated load AC15 (250 V)	750 VA
Min. switching load	10 V / 10 mA

COIL

Operation range	$\leq 0,8 - 1,1 \times U_N$
Rated power (AC/DC)	$\leq 0,5 \text{ W}$
Release voltage	$\geq 0,1 \times U_N$
Coil resistance	$\pm 10\%$

Coil data

INSULATION

Contact open	1 KV
Coil /Contacts	4 KV
Insulation IEC 61810-1	4 KV/3
Between contacts	

SPECIFICATIONS

Ambient temperature	- 40 °C ... + 80 °C
Operation / Release time	$\leq 30 \text{ ms} / \leq 20 \text{ ms}$
Protection category	IP40
Electrical life DC / Mechanical life	1·10 ⁵ op / 10·10 ⁶ op (AC) 20·10 ⁶ op (DC)
Weight	17 g

ACCESSORIES

Sockets	STB10H0 (24-240 VAC/VDC)
Bridge coil/contact 20 Units)	Bridge coil/contact 20 Units): BT10K

ORDERING CODE

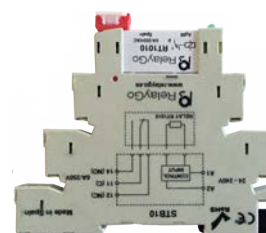
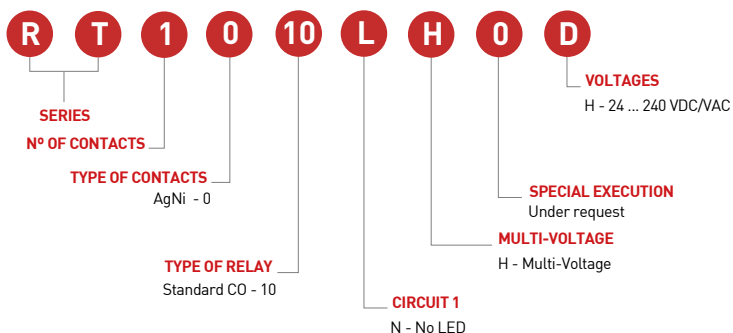

CONNECTION DIAGRAM

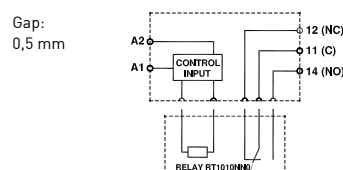

FIG. 1 ELECTRICAL LIFE AC LOAD

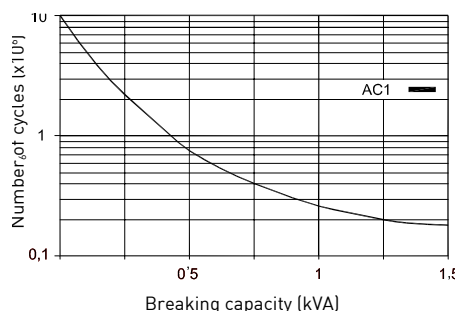
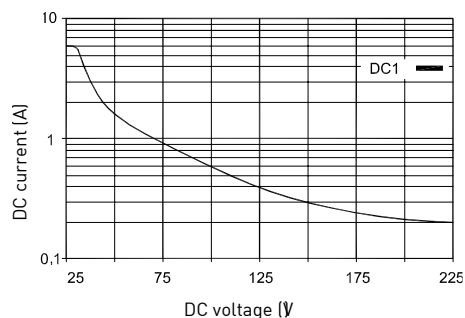
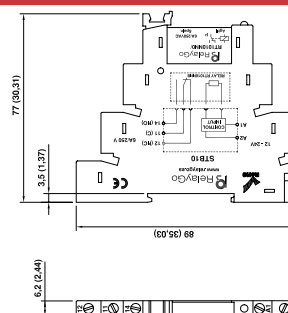

FIG. 2 MAX. DC BREAKING CAPACITY



DIMENSIONS mm [inch]



TECHNICAL APPROVALS



In process In process In process In process

IEC 61810; EN 60947



Kühn Controls AG

Notes:

You want more information about this product, please call us: tel: +49 (0)7082-940000 or send us a fax: +49 (0)7082-940001, or email: sales@kuehn-controls.de or visit our Website: www.kuehn-controls.de